

Ocean Enclosures

PCB Drawing of Din Rail/Wall Mounting Enclosure with 8 Poles (EL47-08P)

PCB BETWEEN TOP AND BOTTOM OF CASE

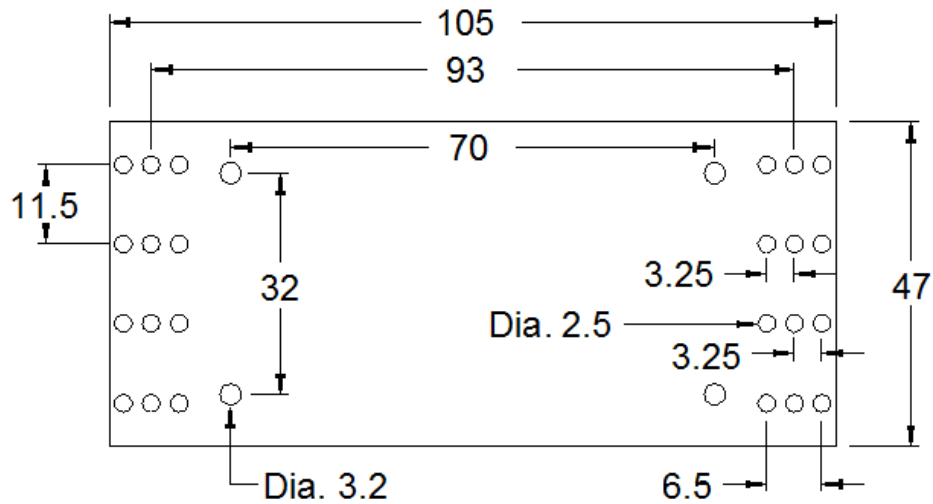

BOTTOM PCB

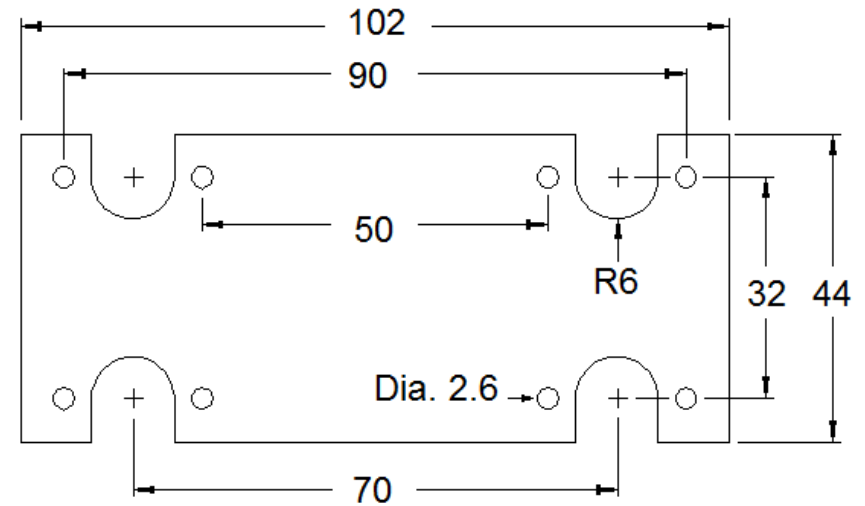

OceanEnclosures.Com
All dimensions are in mm

Slice view of EL47-08P Enclosure

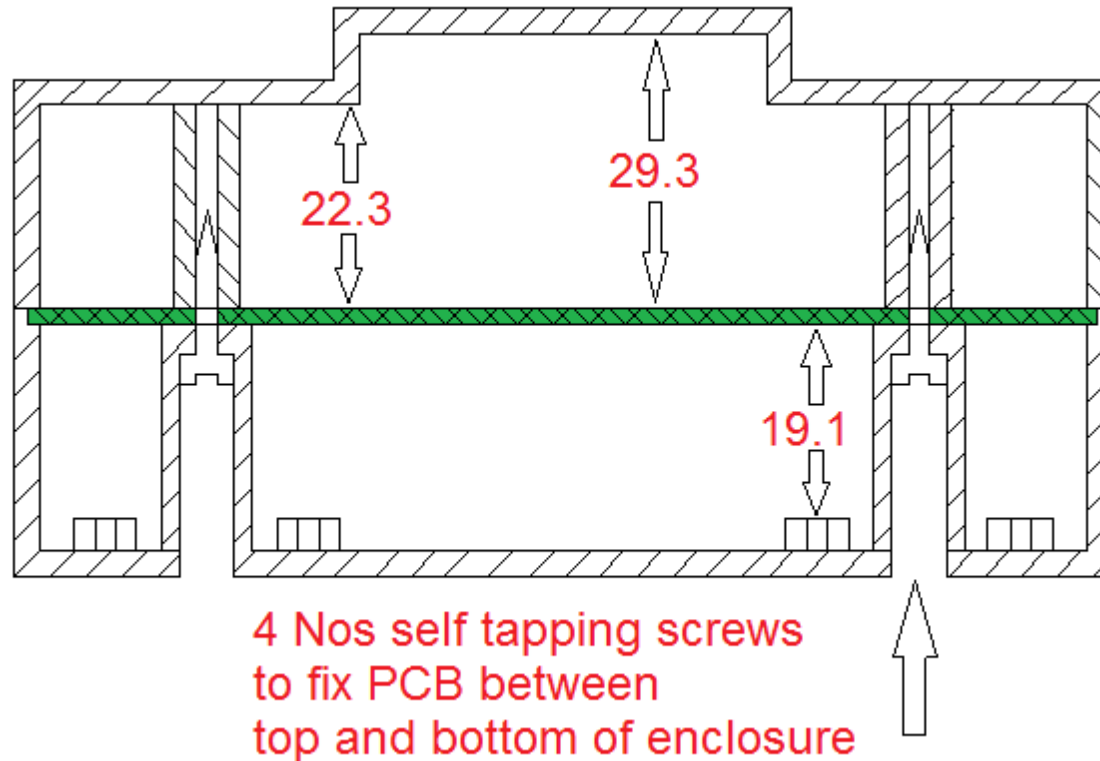

Ocean Enclosures

Website: www.oceanenclosures.com

Email ID: electronicenclosures@gmail.com